

CLC111

Ultra High Slew Rate, Closed Loop Buffer

General Description

The CLC111 is a high performance, closed loop, monolithic buffer designed for applications requiring very high frequency signals. The CLC111's high performance includes an extremely fast 800MHz small signal bandwidth (0.5_{pp}) and an ultra high (3500V/ μ s) slew rate while requiring only 10.5mA quiescent current. Signal fidelity is maintained with low harmonic distortion (-62 dBc 2nd and 3rd harmonics at 20MHz). These performance characteristics are for a demanding 100 Ω load.

Featuring a patented closed loop design, the CLC111 offers nearly ideal unity gain (0.996) with a very low (1.4 Ω) output impedance. The CLC111 is ideally suited for buffering video signals with its 0.15%/0.04° differential gain and phase performance at 4.43MHz. Power sensitive applications will benefit from the CLC111's excellent performance on reduced or single supply voltages.

Constructed using an advanced, complementary bipolar process and National's proven high performance architectures, the CLC111 is available in several versions to meet a variety of requirements.

Enhanced Solutions (Military/Aerospace)

SMD Number: contact factory

Space level versions also available.

For more information, visit <http://www.national.com/mil>

Features

- Very wideband (800MHz)
- Ultra high (3500V/ μ s) slew rate

- Very low output impedance (1.4 Ω)
- Low (-62 dBc) 2nd/3rd harmonics @ 20MHz
- 60mA output current (± 5 supplies)
- Single supply operation (0 to 3V supply min.)
- Evaluation boards and Spice models

Applications

- Video switch buffers
- Test point drivers
- High frequency active filters
- Wideband DC clamping buffer
- High-speed peak detector circuits

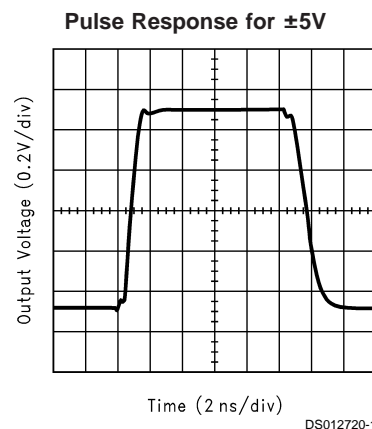

Connection Diagram

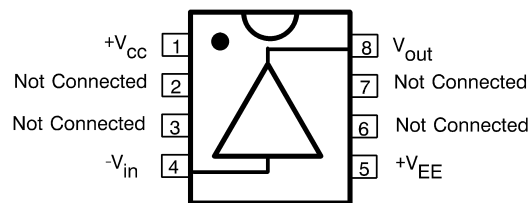

**Pinout
DIP & SOIC**

DS012720-2

Typical Application

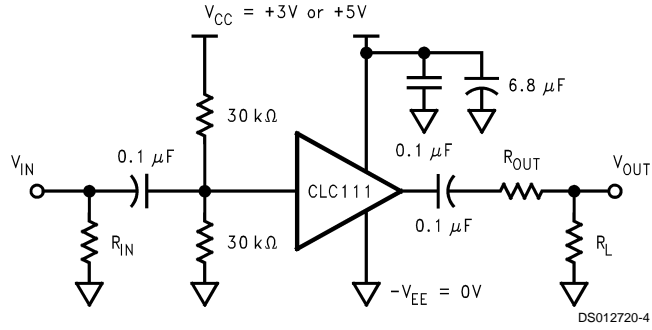

Single-Supply Circuit

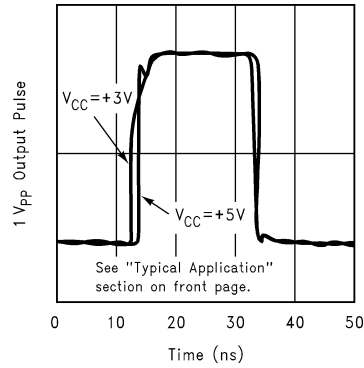

Pulse Response

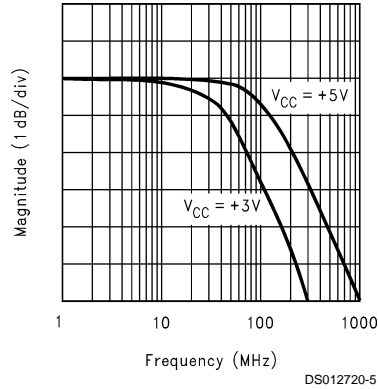

Small Signal Bandwidth

Ordering Information

Package	Temperature Range Industrial	Part Number	Package Marking	NSC Drawing
8-pin plastic DIP	-40°C to +85°C	CLC111AJP	CLC111AJP	N08E
8-pin plastic SOIC	-40°C to +85°C	CLC111AJE	CLC111AJE	M08A

Absolute Maximum Ratings (Note 1)

If Military/Aerospace specified devices are required, please contact the National Semiconductor Sales Office/Distributors for availability and specifications.

Supply Voltage (V_{CC}) $\pm 7.0V$

I_{OUT}
Output is short circuit protected to ground, but maximum reliability will be maintained if I_{OUT} does not exceed...

80mA

Input Voltage $\pm V_{CC}$

Maximum Junction Temperature Range $+150^{\circ}C$

Operating Temperature Range $40^{\circ}C$ to $+85^{\circ}C$

Storage Temperature Range $-65^{\circ}C$ to $+150^{\circ}C$

Lead Solder Duration ($+300^{\circ}C$) 10 sec

ESD rating 1000V

Operating Ratings

Thermal Resistance

Package	(θ_{JC})	(θ_{JA})
MDIP	$70^{\circ}C/W$	$125^{\circ}C/W$
SOIC	$65^{\circ}C/W$	$145^{\circ}C/W$

Electrical Characteristics

$\pm V_{CC} = \pm 5V$, $R_L = 100\Omega$; unless specified

Symbol	Parameter	Conditions	Typ	Min/Max Ratings (Note 2)			Units
Ambient Temperature		CLC111AJ	$+25^{\circ}C$	$-40^{\circ}C$	$+25^{\circ}C$	$+85^{\circ}C$	
Frequency Domain Response							
SSBW	Small Signal Bandwidth	$V_{OUT} < 0.5V_{PP}$	800	400	400	300	MHz
LSBW	Small Signal Bandwidth	$V_{OUT} < 4.0V_{PP}$	450	250	250	200	MHz
	Gain Flatness	$V_{OUT} < 0.5V_{PP}$					
GFL	Flatness	DC-50MHz	0.02	± 0.1	± 0.1	± 0.2	dB
GFPH	Peaking	DC-200MHz	0.1	1.0	0.5	0.5	dB
GFRH	Rolloff	DC-200MHz	0.1	0.8	0.8	1.2	dB
DG	Differential Gain	$R_L = 150\Omega$, 4.43MHz,	0.15	0.4	0.25	0.25	%
DP	Differential Phase	$R_L = 150\Omega$, 4.43MHz	0.04	0.08	0.08	0.08	deg
Time Domain Response							
TRS	Rise and Fall Time	0.5V step	0.6	0.8	0.8	1.1	ns
TRL		4.0V step	1.0	1.4	1.4	1.7	ns
TS	Settling Time to $\pm 0.1\%$	2.0V Step	16	20	20	20	ns
OS1	Overshoot	4V Step	0	8	5	5	%
SR	Slew Rate	4V Step	3500	2700	2700	2300	V/ μ sec
Distortion And Noise Performance							
HD2	2nd Harmonic Distortion	$2V_{PP}$, 20MHz	-62	-47	-50	-50	dBc
HD3	3rd Harmonic Distortion	$2V_{PP}$, 20MHz	-62	-55	-55	-52	dBc
	Equivalent Output Noise						
VN	Voltage	$> 1MHz$	4.0	4.8	4.8	5.3	nV/\sqrt{Hz}
ICN	Current	$> 1MHz$	1.6	4.0	3.0	3.0	pA/\sqrt{Hz}
Static, DC Performance							
GA1	Small Signal Gain	No Load	0.996	0.994	0.994	0.992	V/V
GA2	Small Signal Gain	100 Ω Load	.98	.96	.97	.97	V/V
RO	Output Resistance	DC	1.4	3.0	2.0	2.0	Ω
VIO	Output Offset Voltage (Note 3)		2	17	9	9	mV
DVIO	Average Temperature Coefficient		± 30	± 100	-	± 50	$\mu V/^{\circ}C$
IBN	Input Bias Current (Note 3)		5	30	15	15	μA
DIBN	Average Temperature Coefficient		50	± 187	-	± 100	$nA/^{\circ}C$
PSRR	Power Supply Rejection Ratio		-52	-48	-48	-46	dB

Electrical Characteristics (Continued)

$\pm V_{CC} = \pm 5V$, $R_L = 100\Omega$; unless specified

Symbol	Parameter	Conditions	Typ	Min/Max Ratings (Note 2)			Units
Static, DC Performance							
ICC	Supply Current (Note 3)	No Load	10.5	12	12	12	mA
Miscellaneous Performance							
ILIN	Integral Endpoint Linearity	$\pm 2V$, Full Scale	0.2	1.0	0.5	0.5	%
RIN	Input Resistance		1	0.3	0.7	1	M Ω
CIN	Input Capacitance	CERDIP	2.5	3.5	3.5	3.5	pF
CIN	Input Capacitance	Plastic DIP	1.25	2.0	2.0	2.0	pF
VO	Output Voltage Range	No Load	3.9	3.5	3.6	3.6	V
VOL	Output Voltage Range	$R_L = 100\Omega$	3.5	+3.1,-2.5	3.2	3.2	V
VOL	Output Voltage Range	$R_L = 100\Omega$, 0°C		± 3.1			V
IO	Output Current		60	50,25	50	40	mA
IO	Output Current	0°-70°C		50,35	50	50	mA

Electrical Characteristics

$V_{CC} = +3V$ or $V_{CC} = +5V$, $-V_{EE} = 0V$, $T_A = +25^\circ C$, $R_L = 100\Omega$; unless specified

Symbol	Parameter	Conditions	$V_{CC} = 3V$	$V_{CC} = 5V$	Units
Frequency Domain Response					
SSBW	-3dB Bandwidth	$V_{OUT} < 0.5V_{PP}$	120	300	MHz
LSBW	-3dB Bandwidth	$V_{OUT} < 2.0V_{PP}$		210	MHz
	Gain Flatness	$V_{OUT} < 0.5V_{PP}$			
GFL	Flatness	DC-30MHz	0.5	0.1	dB
GFPH	Peaking	DC-200MHz	0	0	dB
GFRH	Rolloff	DC-60MHz	1.5	0.25	dB
Time Domain Response					
TRS	Rise and Fall Time	0.5V step	3.9	1.2	ns
TRL	Rise and Fall Time	2.0V step		1.5	ns
OS1	Overshoot	1.0V step	3	3	%
SR	Slew Rate	0.5V step	260	425	V/ μ sec
Distortion And Noise Performance					
HD2	2nd Harmonic Distortion	0.5V _{PP} , 20MHz	-46		dBc
		1.0V _{PP} , 20MHz		-55	
HD3	3rd Harmonic Distortion	0.5V _{PP} , 20MHz	-44		dBc
		1.0V _{PP} , 20MHz		-64	
Static, DC Performance					
GA1	Small Signal Gain	AC coupled	0.96	0.97	V/V
		$R_L = \infty$	2.0	4.5	mA
Miscellaneous Performance					
VO	Output Voltage Range	$R_L = \infty$	1.5	3.4	V _{PP}
VOL	Output Voltage Range	$R_L = 100\Omega$	1.1	2.6	V _{PP}

Electrical Characteristics (Continued)

Note 1: "Absolute Maximum Ratings" are those values beyond which the safety of the device cannot be guaranteed. They are not meant to imply that the devices should be operated at these limits. The table of "Electrical Characteristics" specifies conditions of device operation.

Note 2: Min/max ratings are based on product characterization and simulation. Individual parameters are tested as noted. Outgoing quality levels are determined from tested parameters.

Note 3: AJ-level: spec. is 100% tested at +25°C.

Typical Performance Characteristics

Frequency Response vs. Output Swing

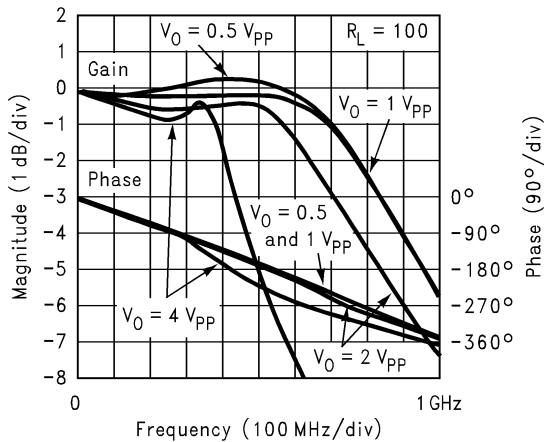

Output Impedance

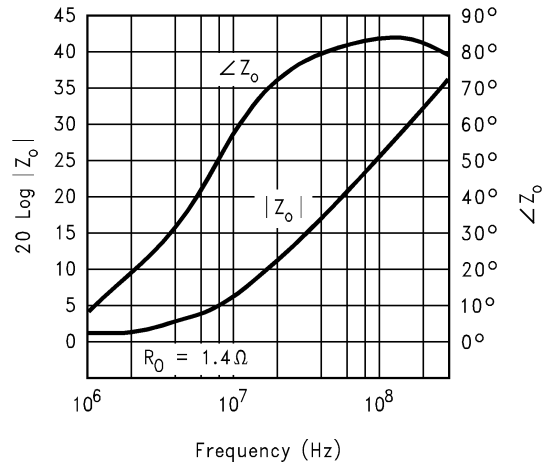

Input Impedance

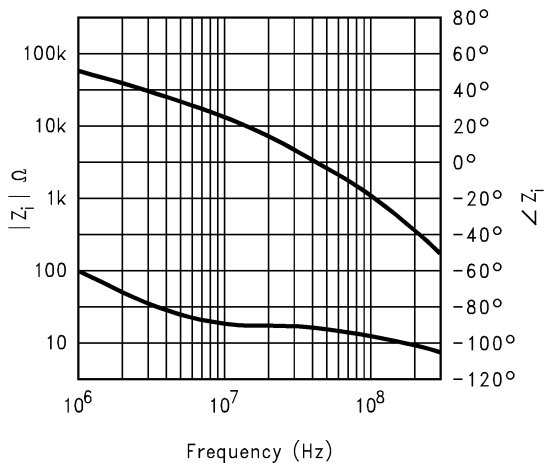

PSRR

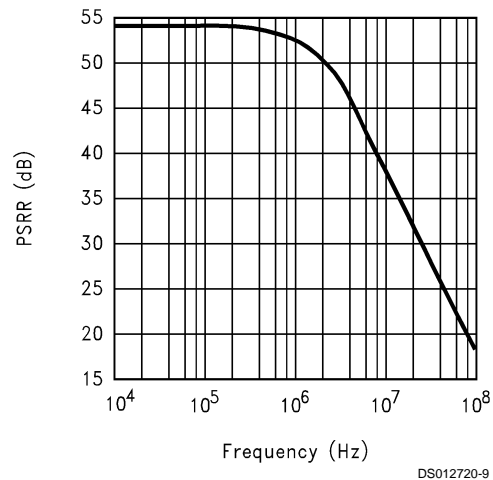

Typical Performance Characteristics (Continued)

Recommended R_S vs. Load Capacitance

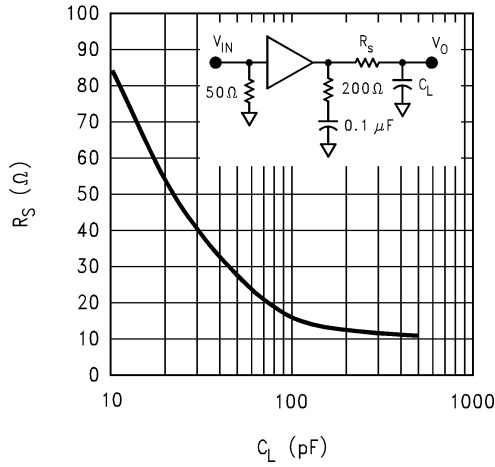

Gain vs. C_L with Recommended R_S

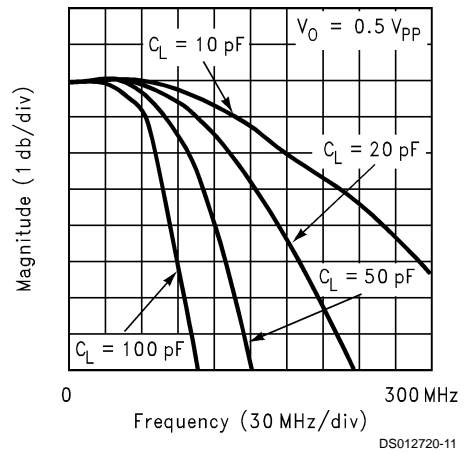

Small Signal Pulse Response

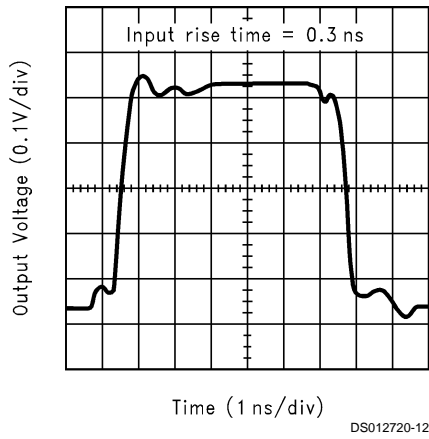

Large Signal Pulse Response

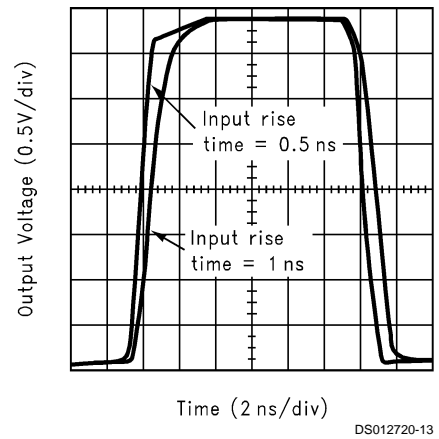

Short-Term Settling Time

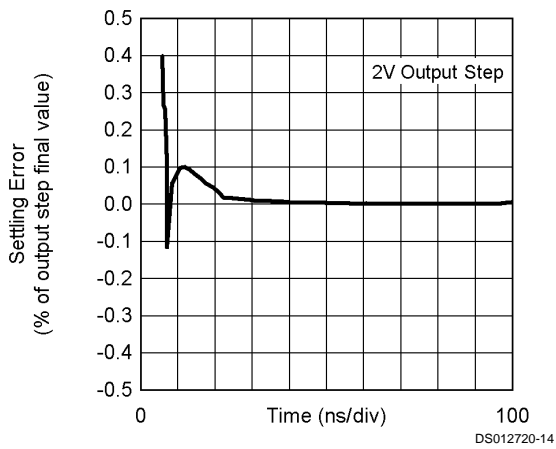

Integral Linearity Error

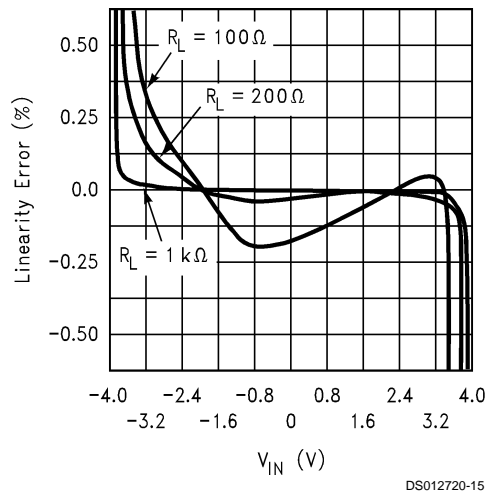

Typical Performance Characteristics (Continued)

Pulse Response

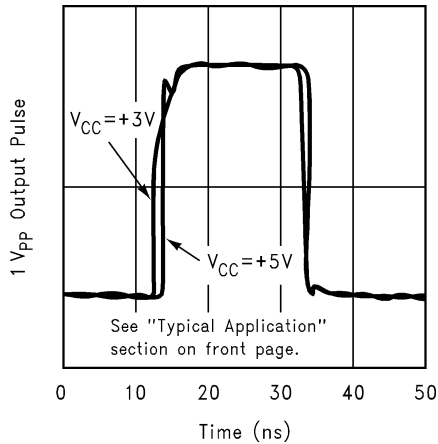

Typical D.C. Errors vs. Temperature

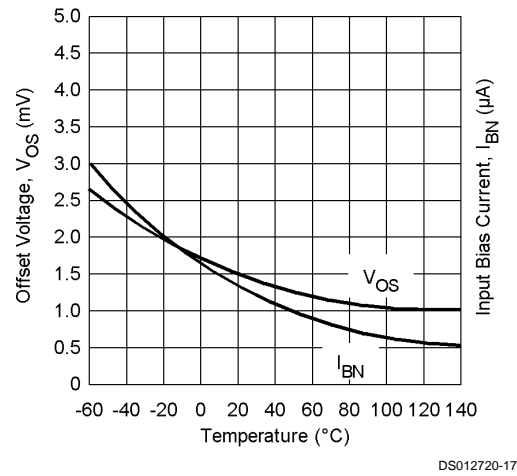

Equivalent Input Noise

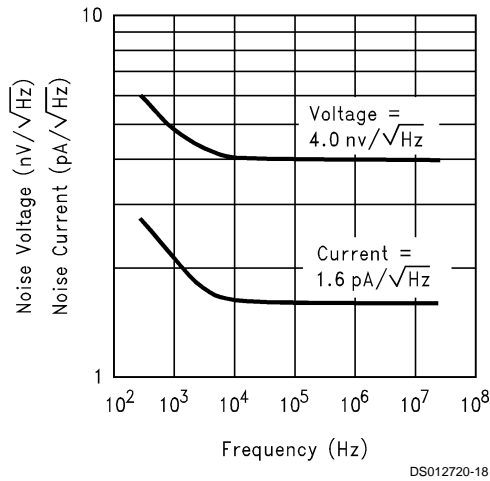

2nd and 3rd Harmonic Distortion

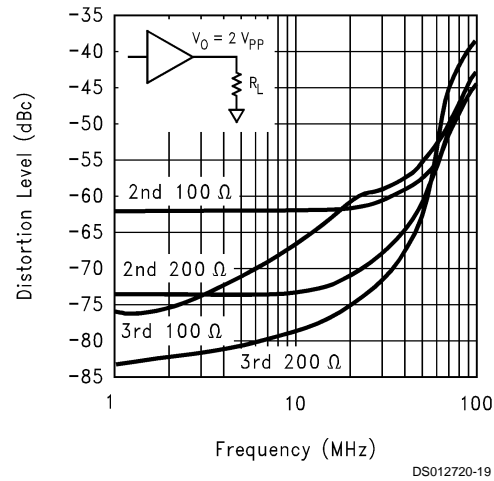

Bandwidth and I_{CC} vs. V_{CC} (Single Supply)

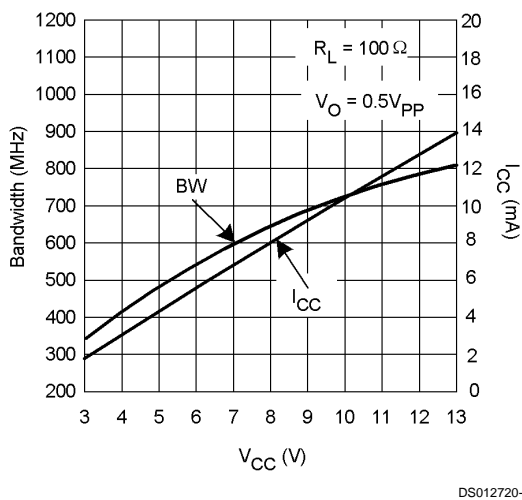

Application Division

Operation

the CLC111 is a low-power, very high speed unity gain buffer. It uses a closed loop topology which allows for accuracy not usually found in high speed open loop buffers. A slew enhanced front end allows for low quiescent power while not sacrificing AC performance.

Single Supply Operation

Although the CLC111 is specified to operate from split $\pm 5V$ power supplies, there is no internal ground reference that prevents operation from a single voltage power supply. For single supply operation, the input signal should be biased at a DC value of $1/2V_{CC}$. This can be accomplished by AC coupling and rebiasing, as shown in *Figure 1*.

The above electrical specifications provide typical performance specifications for the CLC111 at 25° C while operating from a single +3V or a single +5V power supply.

Printed Circuit Layout and Supply Bypassing

As with any high frequency device, a good PCB layout is required for optimum performance. This is especially important for a device as fast as the CLC111.

To minimize capacitive feedthrough, pins 2, 3, 6, and 7 should be connected to the ground plane, as shown in *Figure 1*. Input and output traces should be laid out as transmission lines with the appropriate termination resistors very near the CLC111. On a 0.065 inch epoxy PCB material, a 50 transmission line (commonly called stripline) can be constructed by using a trace width of 0.01" over a complete ground plane.

Figure 1 shows recommended power supply bypassing.

The ferrite beads are optional and are recommended only where additional isolation is needed from high frequency (>400MHz) resonances in the power supply.

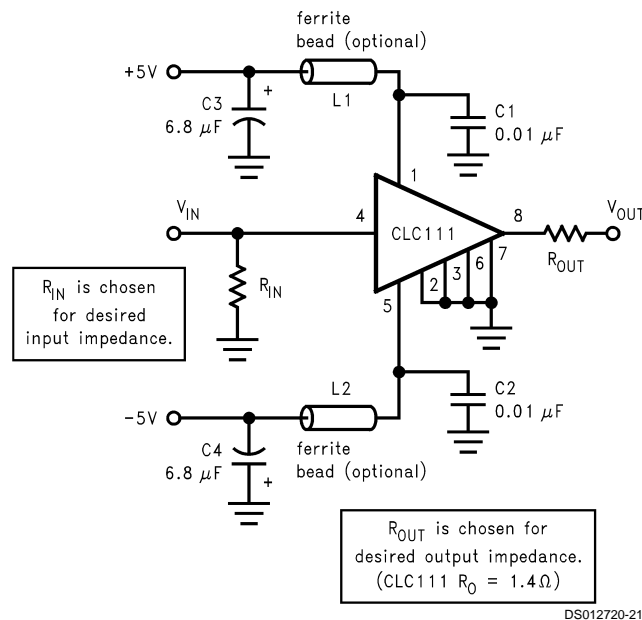

FIGURE 1. Recommended Circuit & Evaluation Board Schematic

Parasitic or load capacitance directly on the output of the CLC111 will introduce additional phase shift in the device. This phase shift can decrease phase margin and increase frequency response peaking. A small series resistor before the capacitance effectively decouples this effect. The graphs in this data sheet illustrate the required resistor value and the resulting performance vs. capacitance.

Precision buffered resistors (PRP8351 series from Precision Resistive Products), which have low parasitic reactances, were used to develop the data sheet specifications. Precision carbon composition resistors or standard

spirally-trimmed RN55D metal film resistors will work, though they will cause a slight degradation of AC performance due to their reactive nature at high frequencies.

Evaluation Boards

Evaluation boards are available from National as part numbers CLC730012 (DIP) and CLC730045 (SOIC). This board was used in the characterization of the device and provides optimal performance. Designers are encouraged to copy these printed circuit board layouts for their applications.

Physical Dimensions inches (millimeters) unless otherwise noted

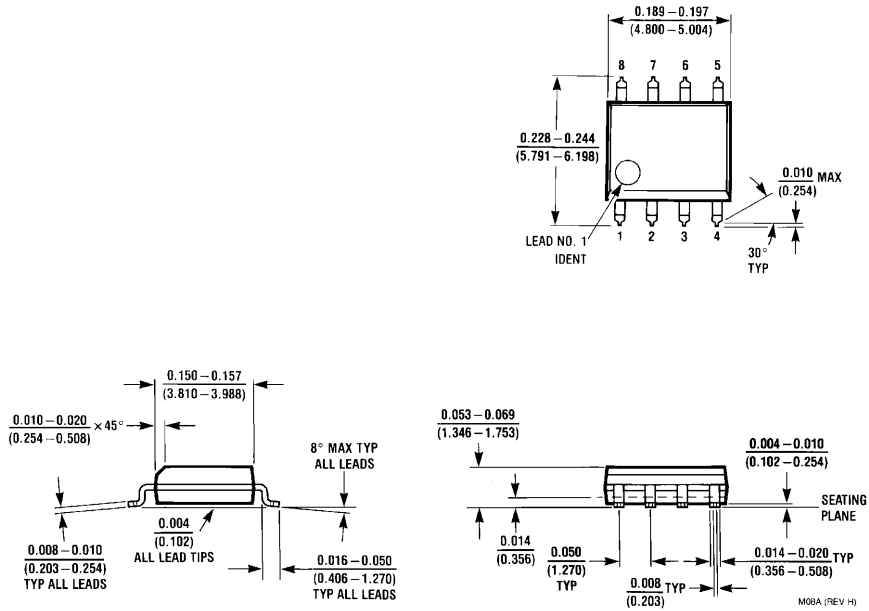

**8-Pin SOIC
NS Package Number M08A**

Physical Dimensions inches (millimeters) unless otherwise noted (Continued)

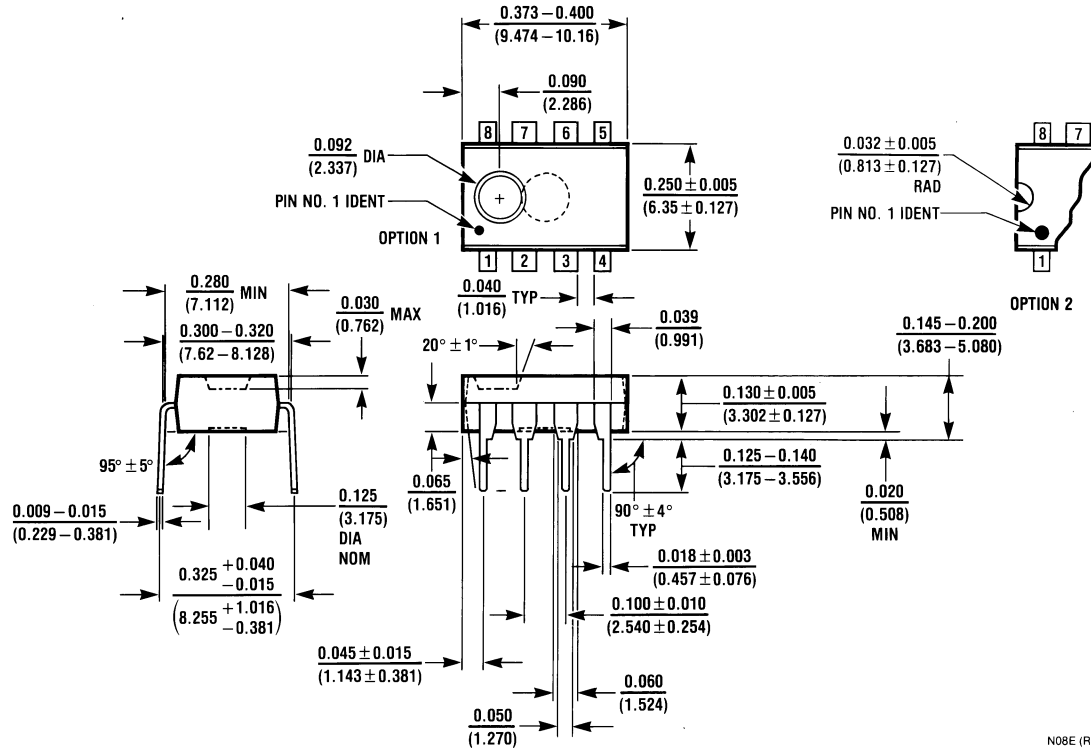

**8-Pin MDIP
NS Package Number N08E**

N08E (REV F)

LIFE SUPPORT POLICY

NATIONAL'S PRODUCTS ARE NOT AUTHORIZED FOR USE AS CRITICAL COMPONENTS IN LIFE SUPPORT DEVICES OR SYSTEMS WITHOUT THE EXPRESS WRITTEN APPROVAL OF THE PRESIDENT AND GENERAL COUNSEL OF NATIONAL SEMICONDUCTOR CORPORATION. As used herein:

1. Life support devices or systems are devices or systems which, (a) are intended for surgical implant into the body, or (b) support or sustain life, and whose failure to perform when properly used in accordance with instructions for use provided in the labeling, can be reasonably expected to result in a significant injury to the user.
2. A critical component is any component of a life support device or system whose failure to perform can be reasonably expected to cause the failure of the life support device or system, or to affect its safety or effectiveness.



National Semiconductor Corporation
Americas
Tel: 1-800-272-9959
Fax: 1-800-737-7018
Email: support@nsc.com
www.national.com

National Semiconductor Europe
Fax: +49 (0) 180-530 85 86
Email: europe.support@nsc.com
Deutsch Tel: +49 (0) 69 9508 6208
English Tel: +44 (0) 870 24 0 2171
Français Tel: +33 (0) 1 41 91 8790

National Semiconductor Asia Pacific Customer Response Group
Tel: 65-2544466
Fax: 65-2504466
Email: ap.support@nsc.com

National Semiconductor Japan Ltd.
Tel: 81-3-5639-7560
Fax: 81-3-5639-7507